



OPTIMAL DESIGN OF RIBBED SLABS: A COMPARATIVE STUDY OF ACI 318 CODES

A. Sheikhalishahi and B. Ahmadi-Nedushan^{*,†}
Department of Civil Engineering, Yazd University, Yazd, Iran

ABSTRACT

This study presents a cost optimization approach for simply supported one-way ribbed slabs, with the primary objective of minimizing concrete and reinforcement costs. A Genetic Algorithm (GA), implemented in MATLAB, is utilized to address this optimization problem. The optimization model incorporates seven discrete design variables: rib dimensions (spacing, bottom/top width, and height), topping slab thickness, flexural reinforcement diameter, and concrete compressive strength. For validation, an initial optimization based on ACI 318-08 with six variables demonstrated a 3% cost reduction compared to established algorithms. To ensure practical relevance, subsequent optimizations incorporated actual market conditions utilizing the 2025 Iranian Building Construction Price List. Transitioning to ACI 318-19 resulted in a 10% increase in optimal cost relative to ACI 318-08, primarily due to stricter shear strength provisions. To mitigate this increase and enhance design efficiency, concrete compressive strength was introduced as a seventh design variable. This expanded optimization was evaluated across spans ranging from 5 to 8 meters, yielding a further 4.4% cost reduction for a 6-meter span. Conclusively, the results demonstrate that the strategic application of higher-strength concrete, informed by real-world market prices, significantly reduces the overall cost of one-way ribbed slab construction.

Keywords: Optimization; Optimal design; Ribbed slab; Genetic algorithm; ACI 318-19.

Received: 28 September 2025; Accepted: 21 November 2025

1. INTRODUCTION

In structural engineering, a slab is a planar element with a thickness negligible compared to its span, designed to transfer loads across roofs, floors, and foundations. A reinforced concrete slab is classified as one-way when it transfers loads primarily in a single direction toward its

*Corresponding author: Department of Civil Engineering, Yazd University, Yazd, Iran

†E-mail address: Behrooz.Ahmadi@yazd.ac.ir (B. Ahmadi-Nedushan)

supports. Specifically, a one-way ribbed slab consists of a thin topping supported by a series of equally spaced joists. Given concrete's negligible tensile strength, the concrete between joists is omitted, significantly reducing the slab's self-weight (dead load). This characteristic renders ribbed slabs particularly cost-effective for spans generally exceeding 5 meters. The embedded joists transfer vertical loads to main beams, which subsequently transmit them to columns and the foundation. Although joist width is typically constant, widening the ribs near supports (e.g., within one meter of the ends) serves as an effective strategy to enhance shear capacity, resulting in a variable cross-section. Notably, cast-in-place ribbed slabs rarely utilize shear stirrups; instead, required shear resistance is achieved through localized widening of the joists at support regions [1].

Given the limitation of global resources and the economic and environmental consequences of their inefficiency, optimizing resource management is critical. Structural optimization provides a robust framework to achieve this objective effectively. Among various methodologies, optimization using metaheuristic algorithms has proven particularly effective [2]. Metaheuristic algorithms generally derive inspiration from natural phenomena or physical laws. By employing stochastic processes and heuristic rules, these algorithms navigate the feasible solution space to iteratively converge upon optimal solutions.

Metaheuristic algorithms have been extensively applied to optimization problems across various civil engineering disciplines [3]. For instance, Chutani and Singh [4] optimized reinforced concrete beam design using the Particle Swarm Optimization (PSO) algorithm in accordance with Indian Standard IS 456:2000. Their objective was to minimize concrete and reinforcement costs, considering beam width, effective depth, and reinforcement area as design variables. Similarly, Ahmadi-Nedushan and Varaee [5] applied PSO to the optimal design of reinforced concrete retaining walls, demonstrating its efficacy in handling design constraints and yielding cost-effective solutions. Camp and Huq [6] explored the optimization of reinforced concrete frames using the Big Bang–Big Crunch (BB-BC) algorithm based on ACI 318-08. Their study aimed to minimize both total cost and CO₂ emissions, with design variables encompassing member dimensions and concrete strength. In a separate study, Ahmadi-Nedushan and Varaee [7] investigated cost minimization for flat slabs under varying support conditions using PSO, subject to ACI 318-08 constraints. More recently, Ahmadi-Nedushan and Almaleeh [8] employed a Genetic Algorithm (GA) to minimize the cost of one-way flat slabs, adhering to ACI 318-19 provisions.

Specifically regarding one-way ribbed slabs, Kaveh and Shakouri Mahmud Abadi [11] conducted a cost optimization study using the Harmony Search (HS) algorithm. Their optimization adhered to ACI 318-05 and incorporated six design variables: topping slab thickness, rib spacing, rib widths (top and bottom), rib height, and flexural reinforcement diameter. Furthermore, Kaveh and Behnam [12] investigated the cost optimization of composite slabs, one-way ribbed slabs, and formwork using multiple metaheuristic algorithms, including Charged System Search (CSS) and Improved Harmony Search (IHS). Their research applied the AISC Load and Resistance Factor Design (LRFD) method alongside ACI 318-05. For the ribbed slab component, the objective was construction cost minimization, utilizing variables such as topping thickness, rib dimensions, and reinforcement diameter. In a separate study, Kaveh and Bijari presented the optimal design of one-way reinforced concrete ribbed slabs using Particle Swarm Optimization (PSO), Colliding Bodies Optimization (CBO), and Democratic Particle Swarm Optimization (DPSO) algorithms [13].

This research, based on the ACI 318-08 code, focused on an objective function that included the costs of concrete, concreting, steel reinforcement, and reinforcement placement. The design variables comprised five geometric parameters (rib height, top rib width, bottom rib width, clear spacing between ribs, and topping slab thickness) and one variable for the flexural reinforcement diameter within the rib. Bijari investigated the optimal cost determination of ribbed concrete slabs based on varying slab loading and span, utilizing the CBO algorithm [14]. The study aimed to assess the influence of these parameters on optimal cost. The design model included variables such as topping slab thickness, rib spacing, bottom rib width, top rib width, rib depth, and reinforcement diameter. The objective function specifically considered the costs of concrete and steel reinforcement. Previous studies on ribbed slab optimization typically utilized the 2005 and 2008 editions of the ACI 318 code, which are now superseded.

In this study, an initial optimization was performed in accordance with ACI 318-08 [15], utilizing six design variables for comparative analysis and validation. Subsequently, the optimization incorporated actual construction costs in Iran, drawing upon the Iranian Building Construction Price List (2025) [16]. Notably, in the Iranian market, reinforcing steel pricing is contingent not only on its weight but also on its diameter, a detail precisely reflected in the price list. Although this condition increases computational complexity, it yields more practical and applicable outcomes—a factor largely overlooked in prior research. The optimization was then re-evaluated using the updated ACI 318-19 code [17] to assess the effects of its revised provisions. Furthermore, to achieve a more substantial reduction in slab cost, concrete compressive strength (f_c') was introduced as an additional design variable. Consequently, the problem was analyzed with this expanded set of seven design variables across various span lengths. For this study, the Genetic Algorithm (GA) from MATLAB's Optimization Toolbox was employed due to its accessibility and comprehensive capabilities for diverse design optimization problems.

The remainder of this paper is organized as follows: Section 2 introduces the Genetic Algorithm (GA), providing a concise description of its characteristics and general procedure as applied to the current problem. Section 3 is dedicated to the formulation of the ribbed slab optimization problem, encompassing the definition of design variables, the objective (cost) function, and problem constraints. This section aims to establish a precise mathematical framework for the effective application of the GA. Section 4 presents two numerical examples. The first involves optimization based on ACI 318-08, with results compared against previous studies for validation. The second example incorporates real market conditions utilizing costs from the Iranian Building Construction Price List (2025), analyzing the same problem under ACI 318-19. Furthermore, by introducing concrete compressive strength as an additional design variable, the ribbed slab problem is re-optimized for various span lengths, and the outcomes are thoroughly analyzed. Finally, Section 5 provides a comprehensive summary and conclusions, highlighting the differences observed between code editions and actual market costs, and evaluating the practical applicability of the derived results.

2. THEORETICAL FOUNDATIONS OF THE GENETIC ALGORITHM AND ITS APPLICATION IN OPTIMIZATION

The Genetic Algorithm (GA) is a metaheuristic optimization technique based on Darwinian

evolutionary theory. Originally introduced by John Holland in the 1970s [18] and further developed by David Goldberg [19], GA simulates natural biological evolution. It operates on a population of potential solutions, known as individuals, which undergo iterative modification. During each generation, individuals are selected based on their fitness to act as parents for generating offspring through recombination (crossover) and stochastic alteration (mutation). This process favors individuals with superior fitness, thereby progressively guiding the population toward an optimal solution. GA is particularly robust for solving complex optimization problems characterized by discontinuous, non-differentiable, or highly nonlinear objective functions, which are often intractable for traditional mathematical methods [20]. The three fundamental operators governing this evolutionary process, namely selection, crossover, and mutation, are detailed in the following sections

2.1. Key Concepts and Components of the Genetic Algorithm

The Genetic Algorithm (GA) operates on a population, which is a collection of individuals (or chromosomes). Each individual represents a potential solution to the optimization problem. These chromosomes are comprised of genes, with each gene corresponding to a specific design variable of the problem being optimized. For instance, if the population size is 50 and there are 4 design variables, the population can be conceptually viewed as a 50×4 matrix.

The initial population is typically generated randomly, though it can also incorporate predefined chromosomes. An individual may occasionally appear more than once within a population. In each iterative step, the algorithm applies a set of evolutionary operators to the current population to produce a new one, which constitutes the subsequent generation.

The fitness function is a pivotal component in the Genetic Algorithm, serving as the primary criterion for quantitatively evaluating the quality of each potential solution (chromosome). This function assigns a numerical fitness score to every chromosome, allowing the algorithm to objectively compare and differentiate between solutions. A higher fitness score typically indicates a superior solution with respect to the optimization objective (e.g., lower cost in a minimization problem, or higher performance in a maximization problem). This scoring mechanism is fundamental for guiding the selection process towards more optimal individuals across successive generations.

Design variables in optimization problems are broadly categorized into two types: continuous and discrete. Continuous variables can assume any real value within a specified range, allowing for infinite possibilities between their lower and upper bounds. In contrast, discrete variables are restricted to a finite, predefined set of distinct values. A common engineering example of a discrete variable is the diameter of a reinforcement bar, which must be selected from a set of standard commercially available sizes.

The Genetic Algorithm implementation within MATLAB's Optimization Toolbox natively supports only continuous and integer variables. To address optimization problems involving discrete variables, a specific mapping strategy is employed. First, the complete set of possible discrete values must be explicitly defined. Then, within the algorithm, the discrete variable is represented as an integer variable. Its lower bound is set to 1, and its upper bound is set to the total number of elements in the predefined discrete set. A subsequent function is then utilized to map these integer values (which act as indices) back to their corresponding discrete values from the original set. For instance, If the discrete variable set is defined as $S =$

[1, 1.6, 2.2, 3.7, 4.1, 7], then the variable is defined for the algorithm as $X = [1, 2, 3, 4, 5, 6]$. The integer values are then interpreted as the indices of the corresponding elements in the discrete set using the relation $X = S(X)$. For example, if the integer value of the variable is 3, the algorithm will use the third value from the set S , which is 2.2.

In the Genetic Algorithm, parent selection is the process by which individuals are chosen from the current population to serve as parents for generating the next generation. This mechanism is crucial as it drives the evolutionary process, ensuring that individuals with higher fitness scores have a greater probability of being selected. It is important to note that a single individual can be selected multiple times as a parent, contributing its genetic material to several offspring. Among the various strategies for implementing the selection operator, the stochastic uniform selection method is considered highly effective. As conceptually illustrated in Figure 1, this method operates by first visualizing an imaginary line where each individual in the population is allocated a segment proportional to its fitness value. The algorithm then traverses this line in equal, predetermined steps. At each step, the individual whose segment is intersected by the current position is selected as a parent. The starting point for this traversal is determined by a single random number, which is always smaller than the step size, ensuring a fair and stochastic distribution of selections across the fitness landscape.

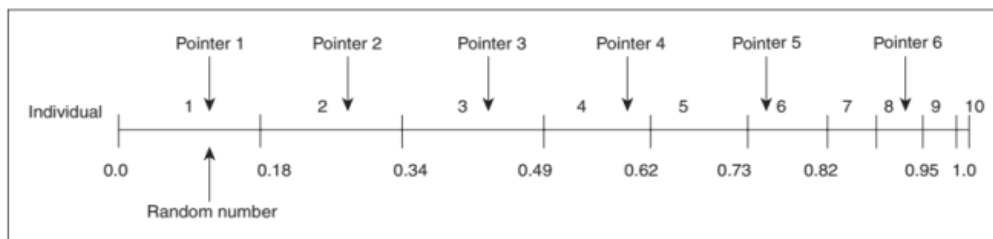

Figure 1: Mechanism of the stochastic uniform selection

The crossover operator is a fundamental genetic operation responsible for generating new offspring by combining genetic material from two parent individuals. This process allows the Genetic Algorithm (GA) to explore new regions of the solution space and to combine desirable traits (genes) from different parents, potentially leading to offspring with superior fitness. In this study, the scattered crossover function is employed. This method first generates a random binary vector (a sequence of 0s and 1s) of the same length as the chromosomes. Then, for each gene position, if the binary vector has a '1' at that position, the gene is inherited from the first parent. Conversely, if the binary vector has a '0', the gene is inherited from the second parent. These selected genes are then assembled to form the new offspring.

To illustrate this process, consider the following example:

- First Parent: [A B C D E F G H]
- Second Parent: [1 2 3 4 5 6 7 8]
- Random Binary Vector: [1 1 0 0 1 0 0 0]

Following the scattered crossover logic, the resulting offspring would be:

- Offspring: [A B 3 4 E 6 7 8]

The mutation operator is a vital component of the Genetic Algorithm, responsible for introducing random alterations into an individual's genes. This stochastic modification is crucial for enhancing genetic diversity within the population, thereby enabling the algorithm to explore a broader and potentially more optimal search space. Without mutation, the algorithm risks premature convergence, where it might converge to a suboptimal solution, as subsequent offspring would merely inherit gene combinations already present in the initial population. This strong dependence on the initial population would significantly reduce the algorithm's robustness and efficiency in finding a global optimum.

Elitism is a strategic approach in Genetic Algorithms that ensures the most successful individuals within a population – those possessing the highest fitness values – are directly transferred, without any alteration, to the subsequent generation. While highly fit individuals naturally have a greater chance of being selected for reproduction, there's always a possibility that their valuable genetic information could be inadvertently lost or diluted through the stochastic operations of crossover or mutation. Elitism safeguards against this by guaranteeing the survival and propagation of these elite members across generations. A beneficial side effect of this mechanism is improved computational efficiency: since the fitness of these elite individuals has already been determined in the preceding generation, their fitness values do not require re-evaluation in the new generation, thereby reducing the total number of computations and overall analysis time.

The termination of the Genetic Algorithm's execution is typically governed by one or a combination of predefined stopping criteria, which are chosen based on the specific optimization problem and design requirements. Common criteria include reaching a maximum specified number of generations, exceeding a predefined computational runtime, achieving a desired target fitness value, or observing no significant improvement in the population's best fitness over a specified number of generations. For a comprehensive visual representation of the Genetic Algorithm's operational sequence, please refer to the flowchart provided in Figure 2.

3. GENERAL REVIEW OF THE PROBLEM AND OPTIMIZATION OBJECTIVES

Optimization, at its core, is the systematic process of identifying the most favorable outcome given a set of predefined constraints. Implementing optimal designs invariably leads to significant efficiencies, resulting in savings across resources, materials, and energy consumption [21]. Fundamentally, any optimization algorithm aims either to minimize the required effort or to maximize a desired benefit, depending on the specific nature of the problem at hand [22].

The meticulous formulation of an optimization problem is paramount. An improperly formulated problem, such as one with an omitted constraint, will yield a flawed solution. Conversely, if the imposed constraints are contradictory, the problem may lack any feasible solution. To mitigate these issues and ensure the accuracy and reliability of the optimization process, a structured five-step approach is recommended for problem formulation [23]:

1. Problem Definition: Clearly articulate the problem to be solved.
2. Information Gathering: Collect all relevant data and parameters pertaining to the problem.
3. Design Variable Identification and Definition: Specify the parameters that can be altered to achieve the optimal solution.
4. Objective Function Identification: Define the mathematical function(s) that quantify the goal to be minimized or maximized.
5. Constraint Determination: Establish all limitations and boundaries that the design variables and objective function(s) must satisfy.

The initial two steps of this formulation process are comprehensively detailed in the subsequent section, which focuses on numerical examples.

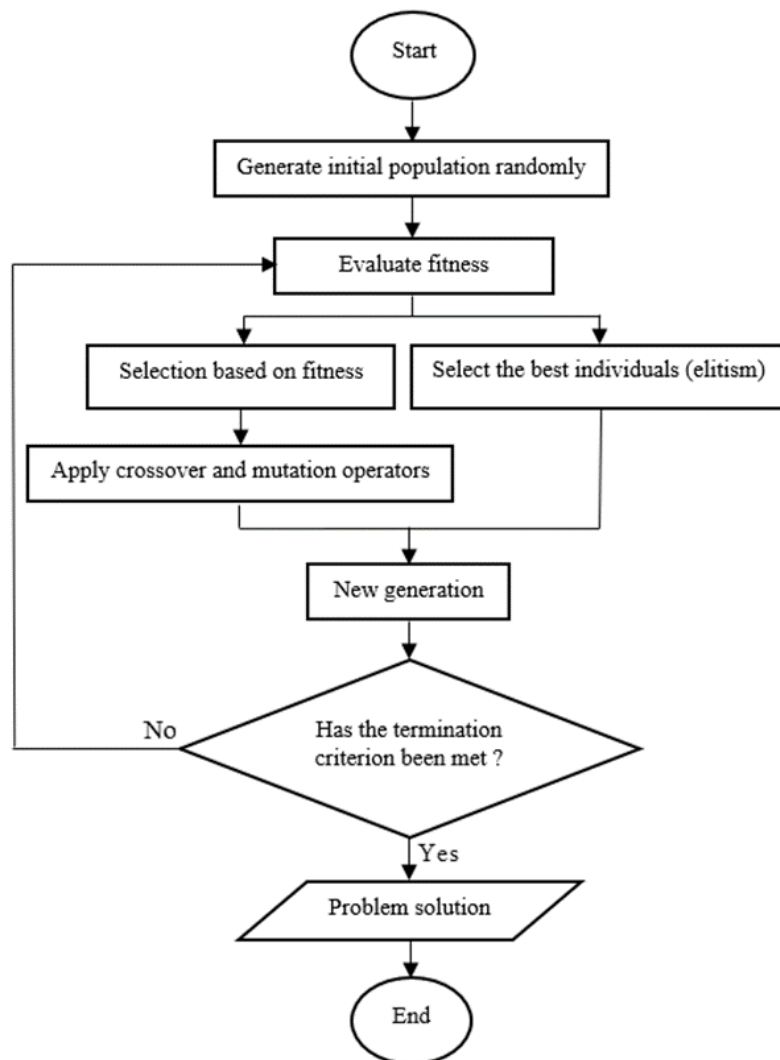

Figure 2: Flowchart of the Genetic Algorithm

3.1 Design Variables and Their Ranges

The optimization problem under consideration involves a total of seven design variables. Six of these variables, depicted graphically in Figure 3, are geometric dimensions of the one-way ribbed slab:

- Topping slab thickness (X_1)
- Clear spacing between ribs (X_2)
- Width of the rib at the bottom (X_3)
- Width of the rib at the top (X_4)
- Diameter of bottom reinforcement (X_5)
- Rib height (X_6)

The seventh design variable, X_7 , represents the concrete compressive strength (f'_c). The permissible ranges and specific values for each of these seven design variables are comprehensively detailed in Table 1.

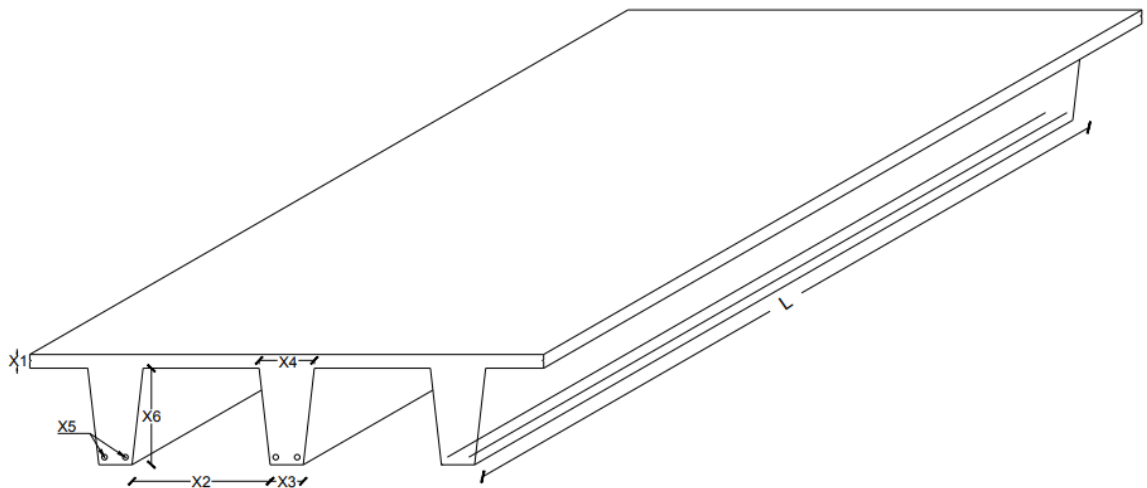

Figure 3: Slab cross-section and design variables

Table 1: Values of Design Variables

Description	Design variables (Unit)	Lower bound	Upper bound	Step
Topping slab thickness	X_1 (cm)	5	10	1
clear spacing between ribs	X_2 (cm)	40	75	1
Width of the rib at the bottom	X_3 (cm)	10	25	1
Width of the rib at the top	X_4 (cm)	10	30	1
Diameter of the bottom reinforcement	X_5 (cm)	1	2	0.2
Rib height	X_6 (cm)	15	75	1
Concrete strength	X_7 (MPa)	20	40	5

3.2 Objective Function

The primary objective of this optimization study is to minimize the total cost associated with the one-way ribbed slab. This total cost encompasses the expenses for concrete, reinforcing steel (rebar), concrete placement, and rebar installation. The total cost of the slab,

expressed per meter width (perpendicular to the span), is formulated as follows:

$$Cost = \frac{V_{conc} \times (C_1 + C_2) + W_{steel} \times (C_3 + C_4)}{b} \left(\frac{\$}{m} \right) \quad (1)$$

$$b = X_2 + X_3 \quad (m) \quad (2)$$

Where coefficients C_1 and C_2 represent the cost of concrete and concrete placement (in USD/m³). C_3 and C_4 denote the cost of rebar material and rebar installation (in USD/kg), respectively. Moreover, b , as defined in Equation (2), represents the width of one rib (T-shaped joist); V_{conc} , as defined in Equation (3), denotes the volume of concrete used for one rib along the entire span (in m³); and W_{steel} , as defined in Equation (4), represents the weight of reinforcement used for one rib along the entire span (in kg).

$$V_{conc} = \left(\frac{X_3 + X_4}{2} X_6 + b \times X_1 \right) L \quad (m^3) \quad (3)$$

$$W_{steel} = \left(2\pi \frac{X_5^2}{4} \right) L \times 7.85 \times 10^3 \quad (Kg) \quad (4)$$

Equation (1) can be rewritten as follows:

$$\overline{Cost} = \frac{Cost}{C_1 + C_2} \quad (m^2) \quad (5)$$

$$\overline{Cost} = \frac{V_{conc} + W_{steel} \left(\frac{C_3 + C_4}{C_1 + C_2} \right)}{b} \quad (m^2) \quad (6)$$

Based on the conducted assessments and evaluations, the value of $\left(\frac{C_3 + C_4}{C_1 + C_2} \right)$ can be considered as 0.04 [9]. Therefore, we have:

$$\overline{Cost} = \frac{V_{conc} + W_{steel} \times 0.04}{b} \quad (m^2) \quad (7)$$

3.3 Design Constraints: Analysis According to ACI 318-08 and ACI 318-19

The design constraints for the one-way ribbed slab are formulated based on the provisions of both the ACI 318-08 [13] and ACI 318-19 [15] building codes. Throughout this section, any discrepancies or updates between these two code editions are explicitly highlighted. Furthermore, Table 2 comprehensively lists and defines all parameters utilized in the formulation of these constraints.

Table 2: Description of the Problem Parameters

Description	Parameter (Unit)	Value
Span length of the slab	L (m)	6
Concrete compressive strength	(MPa)	28
Reinforcement yield stress	f_y (MPa)	420
Uniformly distributed dead load	DL (kN/m ²)	0.78
Uniformly distributed live load	LL (kN/m ²)	4
Unit Weight of Concrete	W_c (kN/m ³)	24
Unit weight of reinforcement	W_s (kN/m ³)	78.5
Flexural strength reduction factor	ϕ_f	0.9
Shear strength reduction factor	ϕ_s	0.75
Modulus of elasticity of reinforcement	E (MPa)	200000
Ultimate strain of concrete	ϵ_{cu}	0.003
Yield strain of reinforcement	ϵ_{ty}	0.0021

3.3.1 Flexural Constraint of the Joist

For one-way ribbed slabs, each joist is designed as a T-shaped cross-section. The effective flange width (b_e) of this T-section is determined by specific provisions, which vary slightly between code editions. According to ACI 318-08 [13], the effective flange width is calculated using Equation (8):

$$b_e = \min\left(\frac{L}{4} \cdot (X_3 + 16X_1), (X_3 + X_2)\right) \quad \text{in ACI 318 - 08} \quad (8)$$

In contrast, ACI 318-19 [15] specifies the effective flange width using Equation (9)

$$b_e = X_3 + \min\left(\frac{L}{4} \cdot 16X_1, X_2\right) \quad \text{in ACI 318 - 19} \quad (9)$$

For calculating the flexural strength in T-shaped sections, two general cases are considered. In the first case, as shown in Fig. 4, the depth of the compression block is less than the slab thickness (i.e., $a \leq X_1$), and the section behaves as a rectangular section:

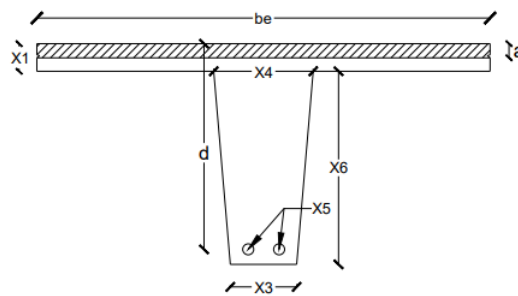

Figure 4: Cross-section of the joist with rectangular behavior

$$A_s = 2\pi \frac{X_5^2}{4} \quad (10)$$

$$\varphi_f M_n = 0.9 A_s f_y \left(d - \frac{A_s f_y}{1.7 f_c' b_e} \right) \quad (11)$$

Where A_s and d represent the flexural reinforcement area and the effective depth of the joist, and M_n is the nominal moment capacity of the joist.

According to Figure 5, in the second case, if the height of the Whitney stress block is greater than the slab thickness (i.e., $a > X_1$), the section behaves as a T-beam and the compression area of the Whitney block is hatched. To simplify calculations and ensure safety, the red area is neglected and for the calculation of the flexural strength, this area is divided into two parts as illustrated in Figure 6:

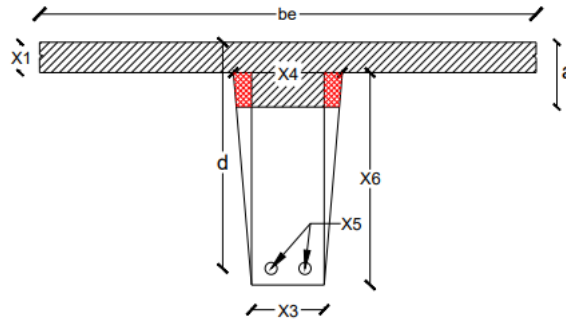
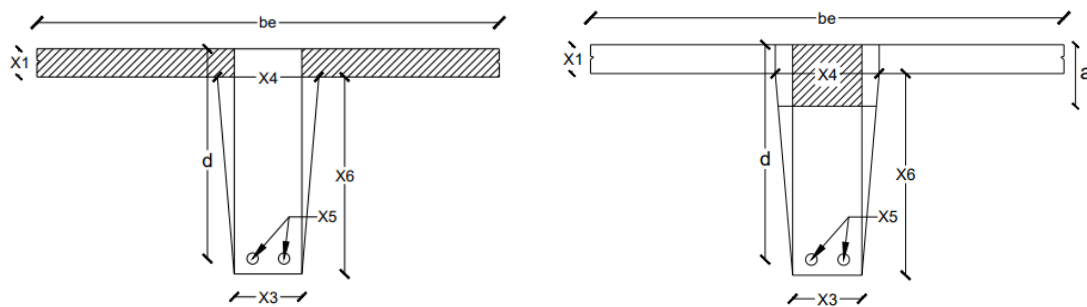

Figure 5: Joist section with T-shaped behavior



(A) Compression area in the flange of the section (B) Compression area in the web of the section

Figure 6: Division of the compression area of the Whitney block

$$A_{sf} = \frac{0.85 f_c' (b_e - X_3) X_1}{f_y} \quad (12)$$

$$a \cong \frac{(A_s - A_{sf}) f_y}{0.85 f_c' X_3} \quad (13)$$

$$\varphi_f M_n = 0.9 \left(A_{sf} f_y \left(d - \frac{X_1}{2} \right) + (A_s - A_{sf}) f_y \left(d - \frac{a}{2} \right) \right) \quad (14)$$

Where A_{sf} is the steel area equivalent to the compression area of the Whitney block in the flange (Figure 6, part A) and a is the height of the Whitney compression block (Figure 6, part B)

$$g_1 = \frac{M_u}{\varphi_f M_n} - 1 \leq 0 \quad (15)$$

g_1 is a measure for assessing the degree of satisfaction of the joist flexural strength constraint. In the following, for each of the constraints, this measure ($g_i \leq 0$, where i is the constraint number) is defined.

3.3.2 Joist Shear Constraint

In this section, the shear strength of the joist without shear reinforcement is calculated. According to the provisions of both ACI 318-08 and ACI 318-19, if the dimensional requirements of the joist are satisfied, the concrete shear strength of the joist can be increased by up to 10 percent:

$$\varphi_s V_n = 0.75 \frac{\sqrt{f_c'}}{6} b_w d \quad \text{in ACI 318 - 08} \quad (16)$$

$$\varphi_s V_n = 0.75 \left(0.66 \lambda_s \rho_w^{\frac{1}{3}} \sqrt{f_c'} b_w d \right) \quad \text{in ACI 318 - 19} \quad (17)$$

$$\lambda_s = \sqrt{\frac{2}{1 + 0.004d}} \leq 1 \quad (18)$$

$$b_w = \frac{X_3 + X_4}{2} \quad (19)$$

$$\rho_w = \frac{A_s}{b_w d} \quad (20)$$

$$g_2 = \frac{V_u}{1.1 \varphi_s V_n} - 1 \leq 0 \quad (21)$$

Where V_n and λ_s are the shear strength of the joist and the size effect factor, respectively. b_w and ρ_w are the average width and the tensile steel ratio of the joist, respectively.

3.3.3 Flexural Constraint of the Topping Slab

The thin slab placed over the joists must be able to transfer loads to the joists through bending and shear behavior. For bending and shear calculations, a one-meter-wide slab section is considered according to Figure 7. In accordance with both code editions, the minimum shrinkage and temperature reinforcement ratio for a concrete strength of 420 MPa is 0.0018:

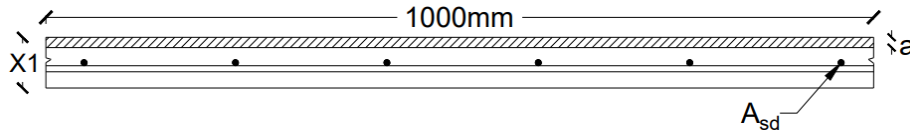

Figure 7: One-meter section of the topping slab

$$A_{sd} = 0.0018 \times 1000X_1 \quad (22)$$

$$\varphi_f M_n = 0.9A_{sd}f_y \left(\frac{X_1}{2} - \frac{A_{sd}f_y}{1.7f'_c'1000} \right) \quad (23)$$

$$g_3 = \frac{M_u}{\varphi_f M_n} - 1 \leq 0 \quad (24)$$

Where A_{sd} is the area of shrinkage and temperature reinforcement.

3.3.4 Shear Constraint of the Topping Slab

$$\varphi_s V_n = 0.75 \frac{\sqrt{f'_c'}}{6} 1000 \frac{X_1}{2} \quad \text{in ACI 318 - 08} \quad (25)$$

$$\varphi_s V_n = 0.75 \left(0.66\lambda_s \rho_w^{\frac{1}{3}} \sqrt{f'_c'} \right) 1000 \frac{X_1}{2} \quad \text{in ACI 318 - 19} \quad (26)$$

$$\rho_w = \frac{A_{sd}}{1000 \frac{X_1}{2}} \quad (27)$$

$$\lambda_s = \sqrt{\frac{2}{1 + 0.004 \frac{X_1}{2}}} \leq 1 \quad (28)$$

$$g_4 = \frac{V_u}{\varphi_s V_n} - 1 \leq 0 \quad (29)$$

3.3.5 Maximum Flexural Reinforcement Constraint of the Joist

This constraint is controlled based on the minimum tensile strain of the bottom

reinforcement of the joist, where the tensile strain in the bottom reinforcement is calculated according to Figure 8 and compared with the allowable value:

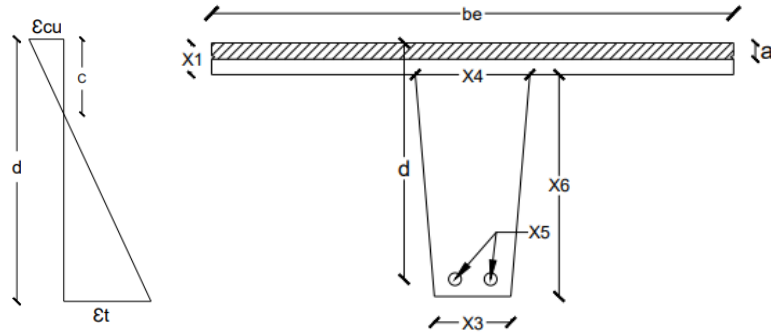

Figure 8: Strain in the tensile reinforcement of the joist

$$\epsilon_t = \frac{(d - C)\epsilon_{cu}}{C} \quad (30)$$

$$C = \frac{a}{\beta_1} \quad (31)$$

$$\beta_1 = \begin{cases} 0.85 & \text{if } 17 \leq f'_c \leq 28 \\ 0.85 - \frac{0.05}{7}(f'_c - 28) & \text{if } 28 < f'_c < 55 \\ 0.65 & \text{if } f'_c \geq 55 \end{cases} \quad (32)$$

$$g_5 = \frac{0.005}{\epsilon_t} - 1 \leq 0 \quad \text{in ACI 318 - 08} \quad (33)$$

$$g_5 = \frac{\epsilon_{cu} + \epsilon_{ty}}{\epsilon_t} - 1 \leq 0 \quad \text{in ACI 318 - 19} \quad (34)$$

Where C and β_1 denote the depth of the neutral axis in the section and the Whitney compression block factor, respectively, and ϵ_t is the strain in the tensile reinforcement of the joist.

3.3.6 Minimum Flexural Reinforcement Constraint of the Joist

$$A_{s \min} = \max \left(\frac{\sqrt{f'_c}}{4f_y} b_w d, \frac{1.4}{f_y} b_w d \right) \quad (35)$$

$$g_6 = \frac{A_{s \min}}{A_s} - 1 \leq 0 \quad (36)$$

In Equation (35), $A_{s,min}$ represents the minimum flexural reinforcement area of the joist.

3.3.7 Minimum Spacing Between Reinforcements Constraint

$$g_7 = \frac{\max\left(25 \quad X_5 \quad \frac{4}{3}d_{agg}\right)}{d_{min}} - 1 \leq 0 \quad (37)$$

In Eq. (37), d_{min} and d_{agg} denote the spacing between the bottom reinforcements of the joist and the nominal diameter of the largest aggregate, respectively.

3.3.8 Minimum overall slab thickness constraint

This constraint is intended to control the slab deflection. Accordingly, as shown in Table 3, the minimum slab thickness is determined based on the support conditions, reinforcement yield stress, and span length (L).

Table 3: Minimum thickness of one-way slab with joists

Support condition	Simply supported	One end continuous	Both ends continuous	Cantilever
Minimum slab thickness	L/16	L/18.5	L/21	L/8

Note: The values calculated in Table 3 correspond to $f_y = 420\text{MPa}$. For other f_y values, the factor $(0.4+f_y/700)$ should be multiplied by the table values.

$$g_8 = \frac{L/16}{X_1 + X_6} - 1 \leq 0 \quad (38)$$

3.3.9 Constraint on the thickness of the topping slab

The thickness of the topping slab shall not be less than 50 mm or one-twelfth of the clear span length.

$$g_9 = \frac{\max\left(\frac{X_2}{12} \quad 50\text{mm}\right)}{X_1} - 1 \leq 0 \quad (39)$$

3.3.10 Dimensional constraint of the joists

The height of the joist must not exceed 3.5 times the minimum width of the joist.

$$g_{10} = \frac{X_6}{3.5 \min(X_3 \quad X_4)} - 1 \leq 0 \quad (40)$$

Moreover, the width of the joist must not be less than 100 mm, and the clear spacing between joists must not exceed 750 mm. These two constraints are considered within the upper and lower bounds of the variables.

4. NUMERICAL CASE STUDIES AND ANALYSIS OF RESULTS

4.1 Optimization of One-Way Ribbed Slab According to ACI 318-08 and Comparison with Previous Studies

In this example, in order to validate the performance of the genetic algorithm, the cost optimization of the one-way ribbed slab shown in Figure 3 has been performed as simply supported at both ends with six design variables (X_1 to X_6), based on ACI 318-08. The values of the parameters required for solving the problem are also presented in Table 2.

For solving the problem using the genetic algorithm, some of its parameters can be adjusted in a way that, while reducing the computation time, leads to improved solutions.

4.1.1 Tuning the Genetic Algorithm Parameters

In this section, by examining several analyses, the appropriate values for the crossover fraction and the elite percentage are determined. The crossover fraction specifies the portion of the population over which the crossover operation is applied.

In this section, the population size is set to 60, the maximum number of generations is 100 (which consequently limits the maximum number of analyses to 6000), and the elite percentages are considered as 1.67, 5, 10, and 15%. The program then combines different values of the crossover fraction parameter (0.1, 0.2, ..., 0.9, 1.0) with the various elite percentages to generate multiple cases. In each case, the algorithm is run 50 times, and the average of the optimal solutions is calculated. In this way, all cases are examined, and the results are presented in the chart shown in Figure 9.

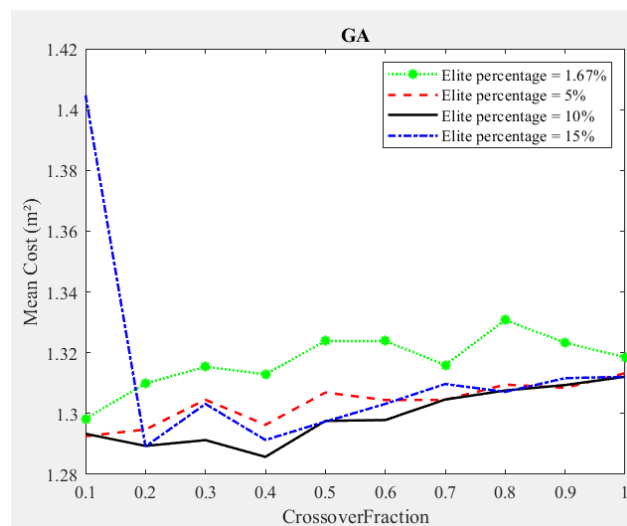

Figure 9: Diagram of the crossover fraction versus mean cost

As shown in Figure 9, the suitable value for the crossover fraction is 0.4, and the elite percentage is 10 percent, which is equivalent to 6 individuals.

In Table 4, the results obtained from solving Example 1 using the genetic algorithm are

compared with those of the HS [9], PSO [11], DPSO [11], and CBO [11] algorithms. The convergence plot of the genetic algorithm is also presented in Figure 10.

Table 4: Comparison of algorithms' results according to ACI 318-08

Algorithm	X ₁ (cm)	X ₂ (cm)	X ₃ (cm)	X ₄ (cm)	X ₅ (cm)	X ₆ (cm)	Cost (m ²)	Number of analysis
HS	5	60	10	10	1.4	35	1.3626	6000
PSO	5	60	17.5	17.5	1.4	32.5	1.3184	6000
DPSO	7.5	67.5	10	10	1.4	30	1.2927	6000
CBO	7.5	67.5	10	10	1.4	30	1.2927	6000
GA	5	60	11	11	1.2	38	1.2535	6000

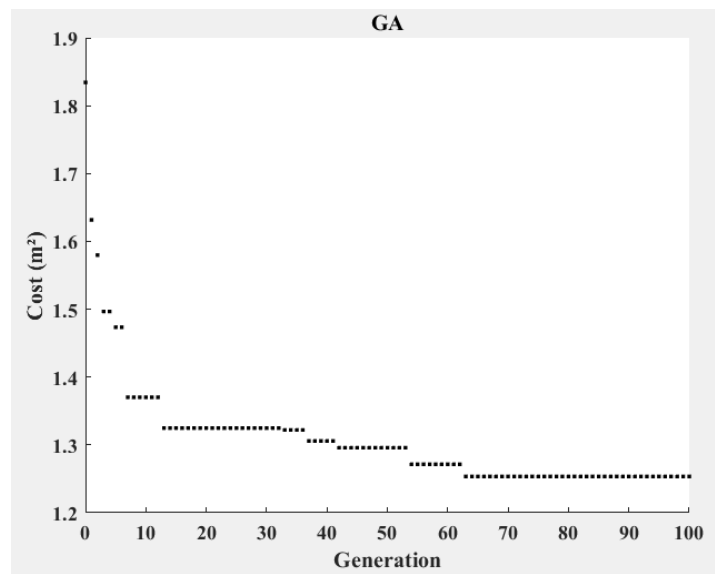

Figure 10: Convergence Plot of the Genetic Algorithm for Example 1

According to Table 4, it should be noted that in the results obtained from other algorithms [9, 11], the step sizes of the geometric design variables (X_1 , X_2 , X_3 , X_4 , X_6) were 2.5 cm. However, in this study, the step sizes of these variables have been reduced to 1 cm. This reduction has led to the cost obtained from the genetic algorithm being approximately 3% lower than that of the DPSO [11] and CBO [11] algorithms. As shown in Figure 10, the algorithm converged to the optimal solution after 63 generations. Table 5 also presents the results of the statistical analysis after 50 runs of the algorithm with the selected parameters (crossover fraction = 0.4 and elite percentage = 10%). In these results, the differences between the best solution and the mean, and the worst solution, are 2.7% and 4.8%, respectively.

Table 5: Statistical Analysis Results of the Genetic Algorithm for Example 1

Standard deviation	Mean	Worst solution	Best solution
0.0277	1.2873	1.3133	1.2535

4.2 Optimization of Ribbed Slab According to ACI 318-19 and the Costs of the Iranian Building Construction Price List

In this section, Example 1 is optimized using the objective function given in Equation (41), based on the costs of the Iranian Building Construction Price List 2025, and the results are presented in Table 7. Then, the problem is solved again according to ACI 318-19 to investigate the effect of the changes between the two versions of the code on the optimal cost. Subsequently, by adding another variable, namely the concrete compressive strength (X7), the problem is re-optimized with seven design variables for different spans (ranging from 5 m to 8 m). The parameters used for solving the problem are given in Table 2. The cost function used for this example includes the costs of providing and placing concrete and reinforcement, and it is defined according to Equation (41):

$$Cost = \frac{V_{conc} \times C_c + W_{steel} \times C_s}{b} \left(\frac{Rial}{m} \right) \quad (41)$$

Where V_{conc} and W_{steel} are the volume of concrete and the weight of reinforcement used for one rib, calculated according to Equations (3) and (4), respectively. Also, C_c is the cost of concrete, determined based on its strength according to items 080105 to 080109 in Table 6, and C_s is the cost of reinforcement, specified according to its diameter from items 070201 to 070203 in Table 6. The parameter b is the width of a full rib, calculated according to Equation (2).

Table 6: Costs of concrete and reinforcement according to the Iranian Building Construction Price List 2025 [14]

Item number	Description	Unit	Unit price (Rial)
070201	Supplying, cutting, bending, and placing deformed reinforcement bars up to 10 mm diameter for reinforced concrete with required tying.	Kg	441,500
070202	Supplying, cutting, bending, and placing deformed reinforcement bars with 12 to 18 mm diameter for reinforced concrete with required tying.	Kg	375,500
070203	Supplying, cutting, bending, and placing deformed reinforcement bars with 20 to 40 mm diameter for reinforced concrete with required tying.	Kg	358,500
080105	Supplying and placing concrete with natural or crushed washed sand and gravel with a specified compressive strength of 20 MPa.	m ³	19,535,000
080106	Supplying and placing concrete with natural or crushed washed sand and gravel with a specified compressive strength of 25 MPa.	m ³	20,162,000
Linear interpolation	Supplying and placing concrete with natural or crushed washed sand and gravel with a specified compressive strength of 28 MPa.	m ³	20,619,200
080107	Supplying and placing concrete with natural or crushed washed sand and gravel with a specified compressive strength of 30 MPa.	m ³	20,924,000
080108	Supplying and placing concrete with natural or crushed washed sand and gravel with a specified compressive strength of 35 MPa.	m ³	21,422,000
080109	Supplying and placing concrete with natural or crushed washed sand and gravel with a specified compressive strength of 40 MPa.	m ³	22,200,000

Note: According to the Price List, if the compressive strength of concrete falls between two consecutive specified strengths, its unit price is calculated by linear interpolation.

Table 7: Results according to ACI 318-08 based on the price list costs

Algorithm	X ₁ (cm)	X ₂ (cm)	X ₃ (cm)	X ₄ (cm)	X ₅ (cm)	X ₆ (cm)	Cost ($\frac{\text{Rial}}{\text{m}}$)
GA	5	60	11	11	1.2	38	19,103,767

In Table 8, the constraint values for the optimal solution are examined, and the active constraints are shown in bold.

Table 8: Constraints values for the optimal solution according to ACI 318-08

Description	Constraints	Value
Joist flexure	g_1	-0.0020
Joist shear	g_2	-0.3081
Topping slab flexure	g_3	-0.5204
Topping slab shear	g_4	-0.8439
Maximum reinforcement	g_5	-0.9717
Minimum reinforcement	g_6	-0.3581
Minimum spacing of reinforcements	g_7	-0.1667
Minimum overall slab thickness	g_8	-0.1279
Minimum topping slab thickness	g_9	0
Joist dimensions	g_{10}	-0.0130

In Table 9, the optimization results based on ACI 318-19 are presented. In addition, Table 10 shows the values of the constraints corresponding to the optimal solution, with the active constraints shown in bold.

Table 9: Results according to ACI 318-19 based on the price list costs

Algorithm	X ₁ (cm)	X ₂ (cm)	X ₃ (cm)	X ₄ (cm)	X ₅ (cm)	X ₆ (cm)	Cost ($\frac{\text{Rial}}{\text{m}}$)
GA	5	48	12	12	1.2	33	21,018,446

Table 10: Constraints values for the optimal solution according to ACI 318-19

Description	Constraints	Value
Joist flexure	g_1	-0.0128
Joist shear	g_2	0.0001
Topping slab flexure	g_3	-0.6931
Topping slab shear	g_4	-0.7901
Maximum reinforcement	g_5	-0.9607
Minimum reinforcement	g_6	-0.3881
Minimum spacing of reinforcements	g_7	-0.3750
Minimum overall slab thickness	g_8	-0.0132
Minimum topping slab thickness	g_9	0
Joist dimensions	g_{10}	-0.2143

The optimal cost per meter of the slab, according to ACI 318-19, is 21,018,446 Rial (equivalent to 2.1018 million Toman), while the optimal cost obtained based on ACI 318-08

is 19,103,767 Rial (equivalent to 1.9104 million Toman). Therefore, applying the provisions of the new code has resulted in approximately a 10% increase in the slab cost. Moreover, according to Table 10, the shear strength constraint of the joist is active in the new code. These differences are due to the reduced concrete shear strength in the new code provisions. Furthermore, Table 11 presents the results of solving the problem according to ACI 318-19 using seven design variables for different span lengths, and Figure 11 shows the diagram of the variation of the optimal cost with respect to the span length.

Table 11: Results based on ACI 318-19 using Price List costs with seven design variables

Span (m)	X ₁ (cm)	X ₂ (cm)	X ₃ (cm)	X ₄ (cm)	X ₅ (cm)	X ₆ (cm)	X ₇ (MPa)	Cost ($\frac{\text{Rial}}{\text{m}}$)
5	5	60	11	12	1.2	27	30	14,501,694
6	5	60	11	11	1.2	38	40	20,136,408
7	5	60	12	12	1.4	40	40	26,953,097
8	5	60	13	13	1.6	45	40	36,102,251

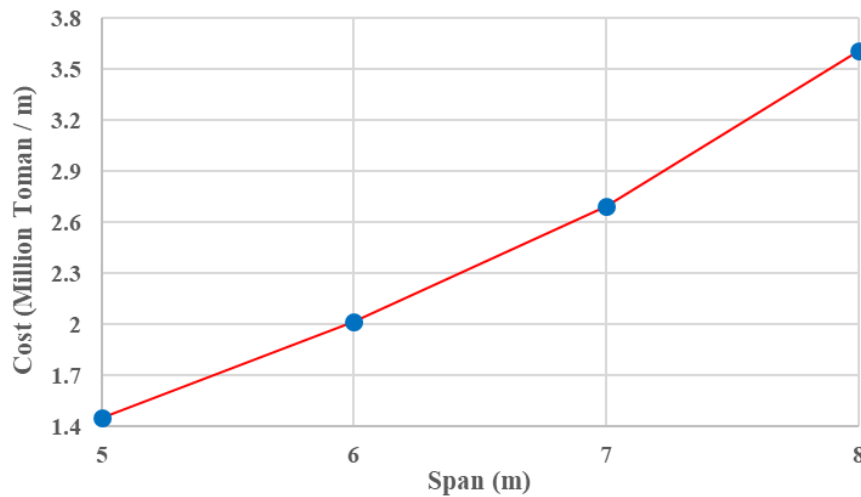

Figure 11: Diagram of the optimal slab cost versus span length

According to Table 11, the optimal cost per meter of the slab under the new code, utilizing seven design variables for a 6-meter span, is 20,136,408 Rial (equivalent to 2.0136 million Toman), which is approximately 4.4% lower than the cost reported in Table 9 (optimal cost according to the new code with six design variables). As indicated in Table 11 and Figure 11, costs exhibit a nonlinear increase with respect to span length. This trend is due to the higher bending moments and shear forces in longer spans, which require larger reinforcement diameters and higher joist heights to resist the applied moments, as well as wider joists to resist the applied shear. Conversely, the topping slab thickness and the clear spacing between joists remain constant across all spans, at 5 cm and 60 cm, respectively, suggesting that these values are optimal given the problem conditions (concrete strength, loading, and costs). Increasing the topping slab thickness elevates both the dead load and the concrete cost, while increasing the clear spacing between joists leads to an increase in the

load-bearing width of the joists, resulting in larger joist dimensions to carry the applied loads and a thicker topping slab to resist bending and shear. Conversely, reducing the clear spacing increases the number of joists per span, which in turn increases the overall slab cost. Moreover, using higher-strength concrete, considering the prices listed in the price schedule, reduces the total slab cost. In this example, the reinforcement cost per kilogram is not fixed and varies depending on the bar diameter. This feature makes this example more complex than the previous one, but considering market realities, ensures that the obtained results are practical and implementable.

4. CONCLUSIONS

By eliminating concrete in the tension zone, ribbed slabs significantly reduce dead load and the overall structural weight. This study utilized a genetic algorithm to optimize a simply supported ribbed slab under various design conditions. The optimization problem involves a nonlinear objective function with discrete design variables. Leveraging the capabilities of MATLAB's Optimization Toolbox within an expanded search space, the algorithm achieved an approximate 3% cost reduction compared to other methods, while maintaining computational efficiency. These results validate the algorithm's efficacy.

Subsequently, the ribbed slab design was optimized, incorporating real-world material costs from the Iranian Building Construction Price List. Since these prices closely reflect actual market conditions in Iran, their inclusion enhances the practical applicability of the findings. A comparison reveals that the optimal cost under ACI 318-19 is approximately 10% higher than under ACI 318-08. Furthermore, the joist shear strength constraint becomes active under the new code provisions, indicating that the revised concrete shear strength provisions lead to a notable reduction in computed shear capacity.

Finally, concrete compressive strength was introduced as a seventh design variable, and the optimization was re-evaluated across span lengths ranging from 5 to 8 meters. Results demonstrate a further cost reduction of approximately 4.4% for a 6-meter span compared to the six-variable scenario. Conclusively, the analysis suggests that utilizing higher-strength concrete, based on current price schedules, yields a reduction in the total slab cost.

REFERENCES

1. Mostofinejad D. *Reinforced Concrete Structures*, Arkan Danesh, 3rd edition, Isfahan, Iran, 2021.
2. Gogna A, Tayal A. Metaheuristics: review and application, *J Exp Theor Artif Intell*, 2013; **25**(4): 503-26.
3. Kaveh A, Dadras Eslamlou A. *Metaheuristic optimization algorithms in civil engineering: new applications*, Springer, Cham, Switzerland, 2020.
4. Chutani S, Singh J. Design optimization of reinforced concrete beams, *J Inst Eng India Ser A*, 2017; **98**(4): 429-35.
5. Kaveh A, Shakouri Mahmud Abadi A. Cost optimization of a composite floor system using an improved harmony search algorithm. *J Constr Steel Res*, 2010; **66**(5): 664-9.

6. Kaveh A, Zolghadr A. Application of Probabilistic Particle Swarm in Optimal Design of Large-Span Prestressed Concrete Slabs. *Iran J Sci Technol Trans Civ Eng*, 2016; **40**(1): 33–40.
7. Ahmadi-Nedushan B, Varae H. Optimal design of reinforced concrete retaining walls using a swarm intelligence technique, *The first international conference on soft computing technology in civil, structural and environmental engineering, UK*, 2009.
8. Camp CV, Huq F. CO2 and cost optimization of reinforced concrete frames using a big bang-big crunch algorithm, *Eng Struct*, 2013; **48**: 363-72.
9. Ahmadi-Nedushan B, Varae H. Minimum cost design of concrete slabs using particle swarm optimization with time varying acceleration coefficients, *World Appl Sci J*, 2011; **13**(12): 2484-94.
10. Ahmadi-Nedushan B, Almaleeh AM. Material cost optimization of one-way reinforced concrete slabs using an elitist genetic algorithm: A sensitivity analysis based on ACI 318-19, *Int J Optim Civil Eng*, 2024; **14**(4): 573-93.
11. Kaveh A, Shakouri Mahmud Abadi A. Cost optimization of reinforced concrete one-way ribbed slabs using harmony search algorithm, *Arab J Sci Eng*, 2011; **36**(7): 1179-87.
12. Kaveh A, Behnam AF. Cost optimization of a composite floor system, one-way waffle slab, and concrete slab formwork using a charged system search algorithm, *Sci Iran*, 2012; **19**(3): 410-16.
13. Kaveh A, Bijari Sh. Optimum cost design of reinforced concrete one-way ribbed slabs using CBO, PSO and democratic PSO algorithms, *Asian J Civil Eng*, 2014; **15**(6): 788-802.
14. Bijari Sh. Determining the Optimal Cost of Concrete Ribbed Slabs Based on Load and Beam Span, *J Concr Struct Mater*, 2021; **5**(2): 167-80.
15. ACI Committee, 318. *Building code requirements for structural concrete (ACI 318-08) and commentary*, American Concrete Institute, 2008.
16. Iranian Plan and Budget Organization. *Iranian Building Construction Price List*, Plan and Budget Organization, Tehran, Iran, 2025.
17. ACI Committee, 318. *Building code requirements for structural concrete (ACI 318-19) and commentary*, American Concrete Institute, 2019.
18. Holland JH. *Adaptation in natural and artificial systems: an introductory analysis with applications to biology, control, and artificial intelligence*, MIT press, 1992.
19. Goldberg DE. *Genetic Algorithms in Search, Optimization and Machine Learning*, Addison-Wesley Longman Publishing Co., Inc., 1989.
20. Javanmardi R, Ahmadi-Nedushan B. Optimal design of double-layer barrel vaults using genetic and pattern search algorithms and optimized neural network as surrogate model, *Front Struct Civ Eng*, 2023; **17**(3): 378-95.
21. Javanmardi R, Ahmadi-Nedushan B. Cost optimization of steel-concrete composite I-girder bridges with skew angle and longitudinal slope, using the Sm toolbox and the parallel pattern search algorithm, *Int J Optim Civil Eng*, 2021; **11**(3): 357-82.
22. Shobeiri V, Ahmadi-Nedushan B. Topology optimization of pretensioned concrete beams considering material nonlinearity, *Int J Optim Civil Eng*, 2019; **9**(4): 629-50.
23. Arora JS. *Introduction to optimum design*, Elsevier, 4th edition, London, United Kingdom, 2017.